



CYVIEW 47-49



LUXURIOUS HOUSES 豪华别墅
MODERN DESIGN 现代设计

LOCATION 地理位置 - GERI - NICOSIA 尼科西亚 - CYPRUS 塞浦路斯

Description 描述

CYVIEW 47-49 will be consisted of 9 unique houses of 3 bedrooms, surrounded by green area. It will be developed in a great piece of land in Geri, with an easy access to all areas in and out of Nicosia. It is a unique opportunity for those who appreciate to have a combination of modern design, quality and luxury.

CYVIEW 47-49 项目是由9幢三居室房型的别墅构成，四周绿地环绕；地处Geri中心位置，出入尼科西亚十分便捷。是现代设计和豪华品质的结合。

CYVIEW 47



House 47A

House 47B

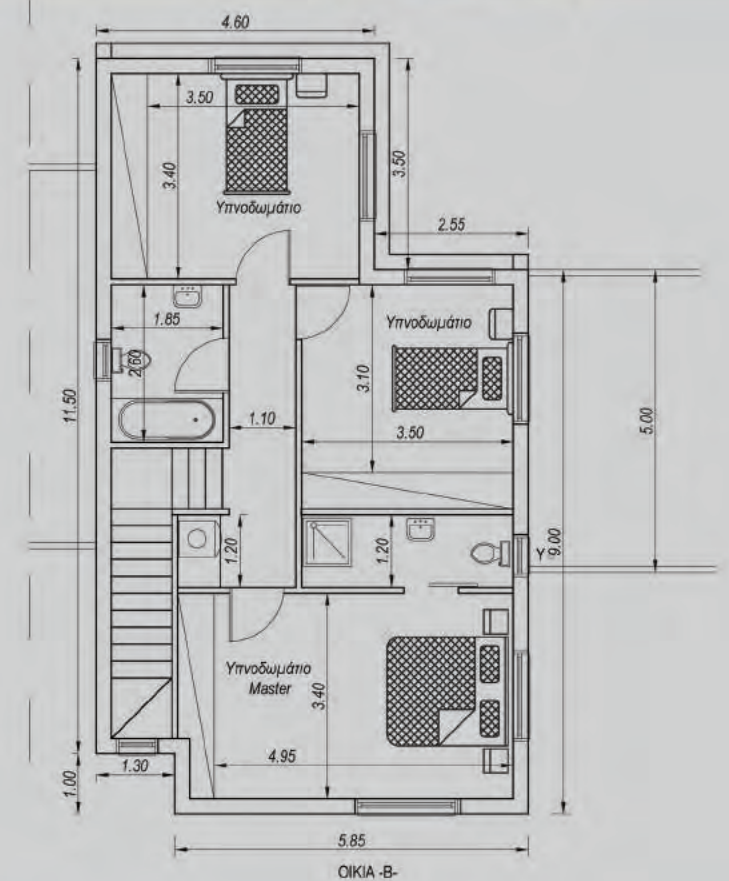
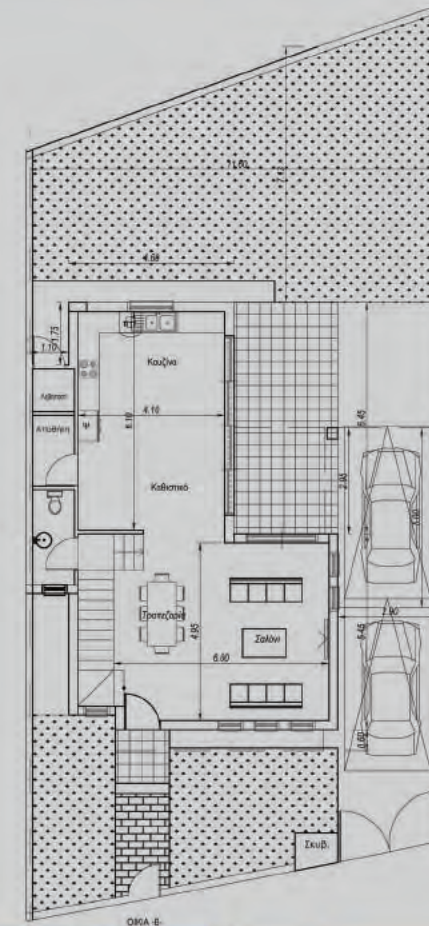
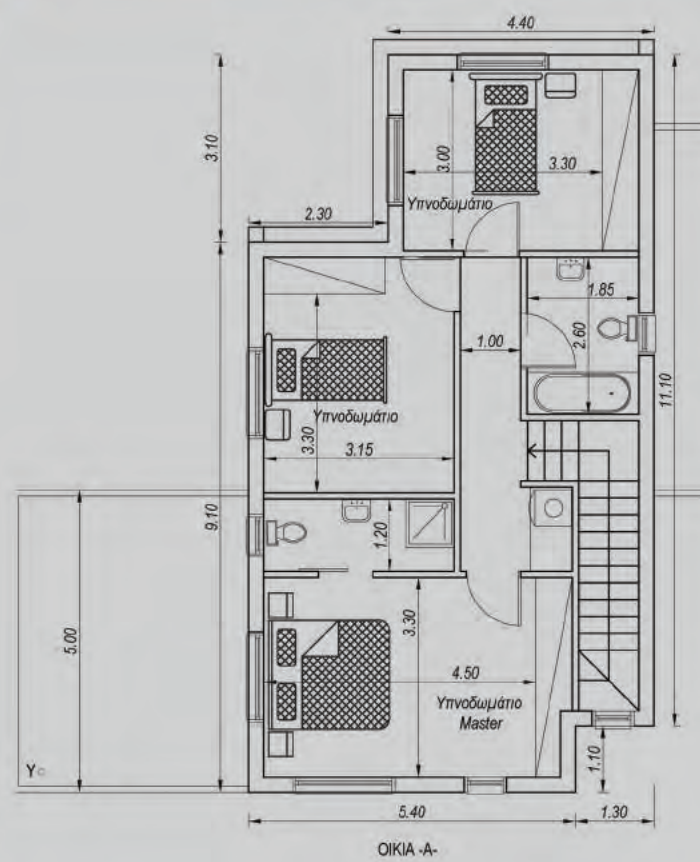
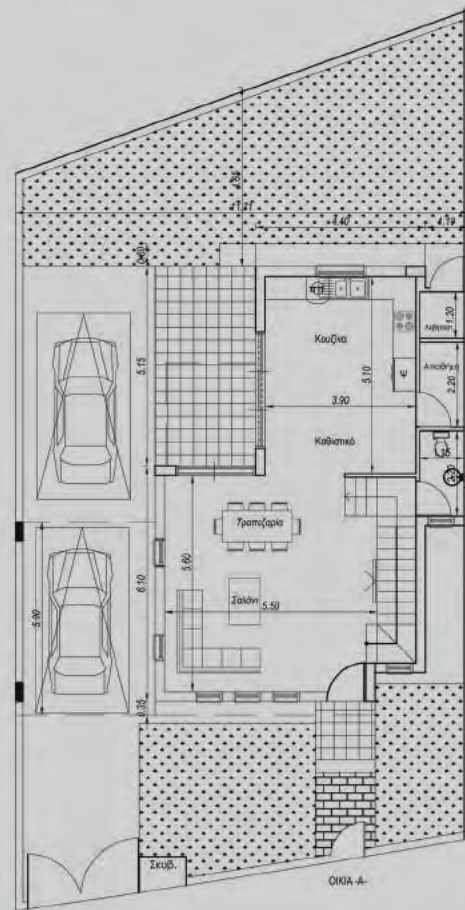

House 47C

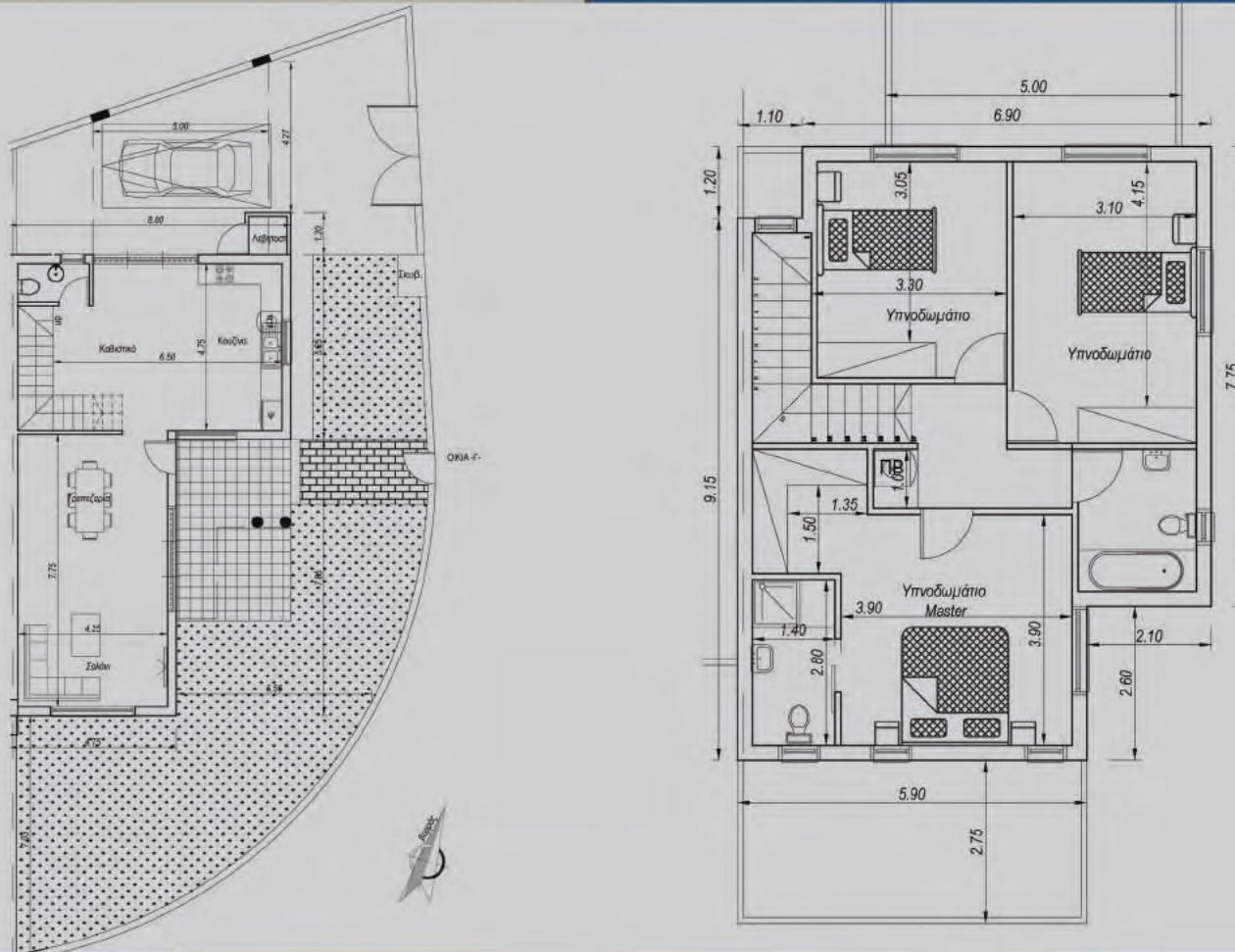

CYVIEW 48



House 48A

House 48B

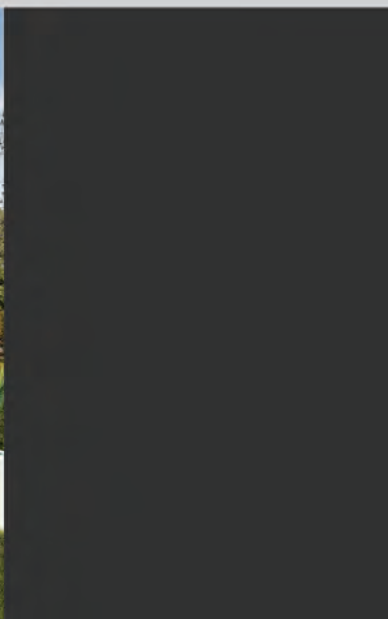
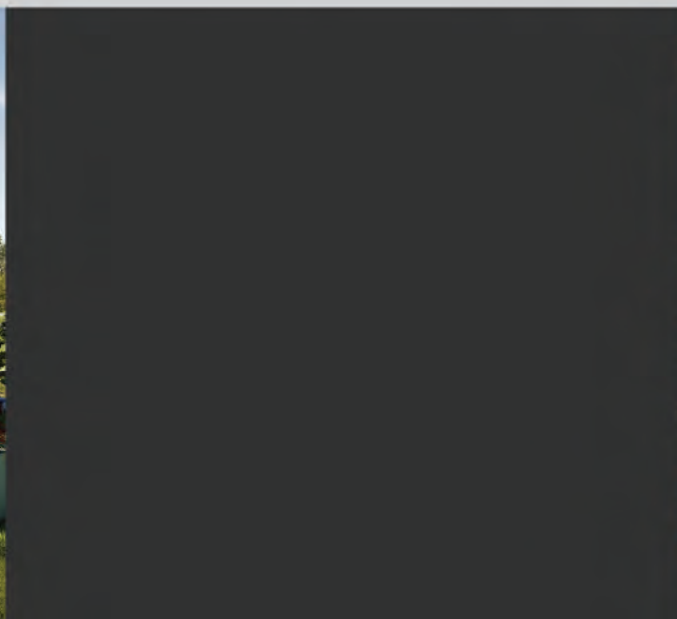
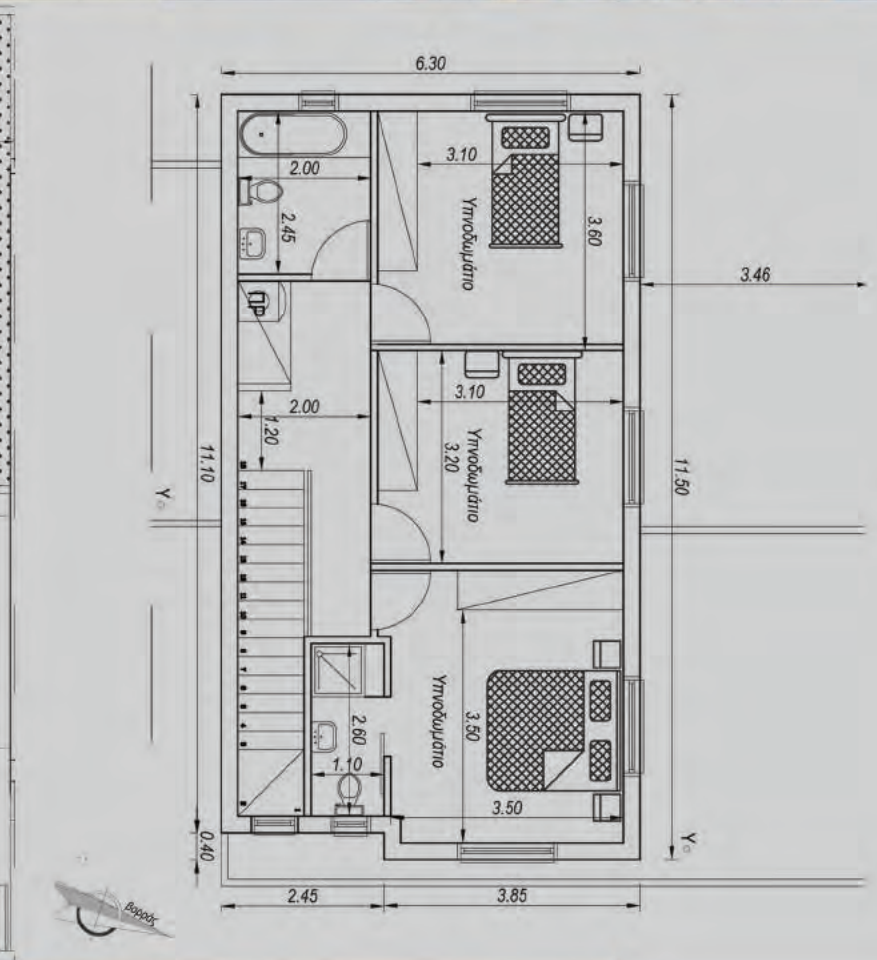
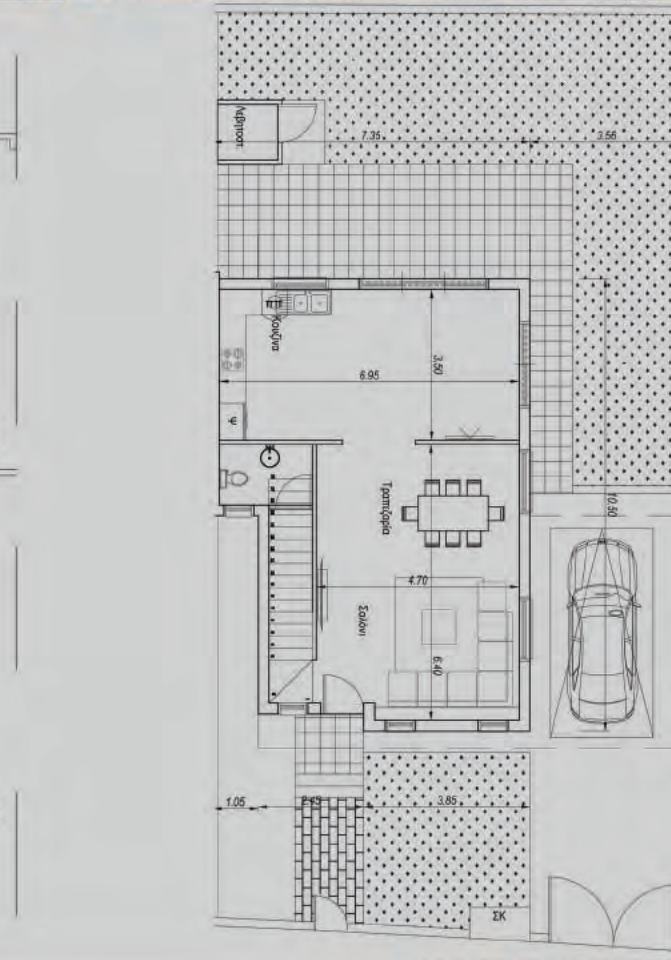
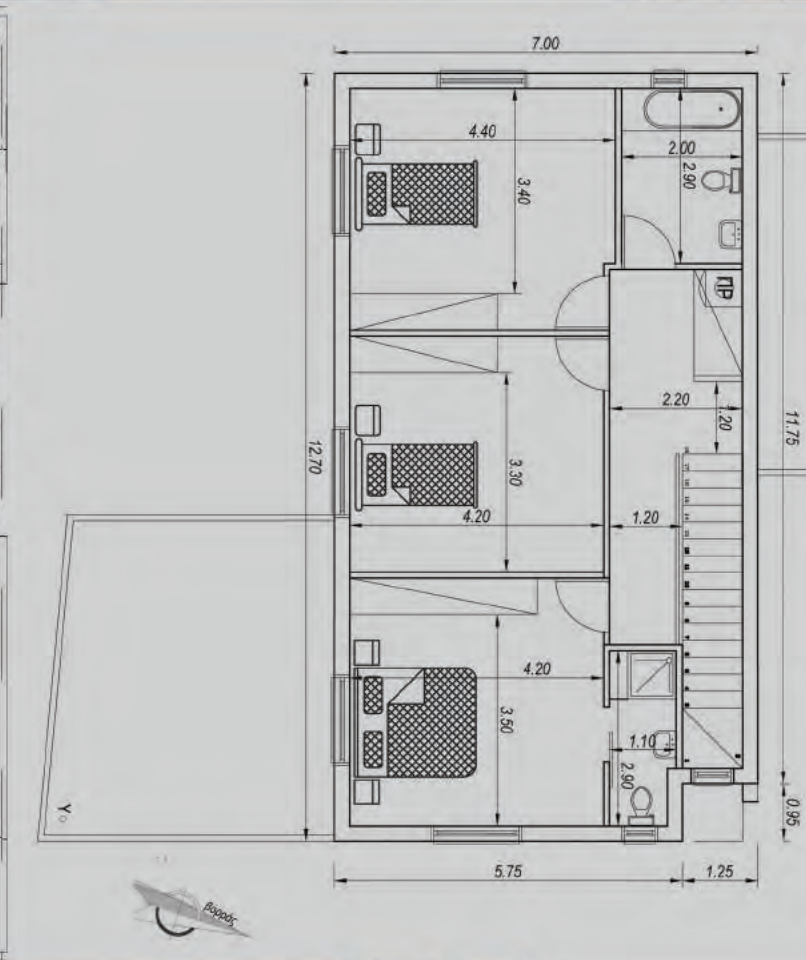
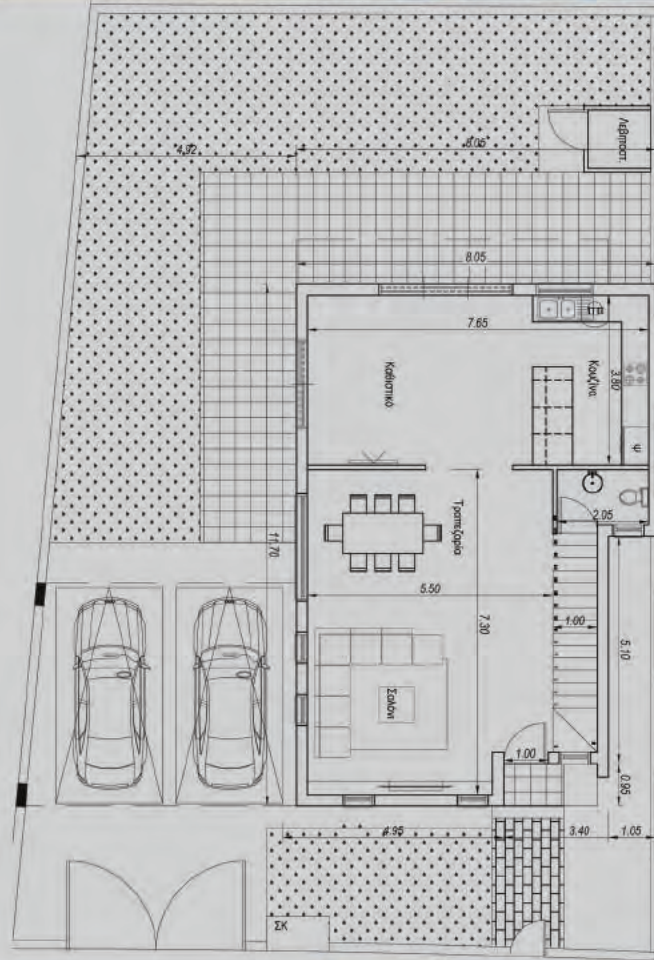

House 48C

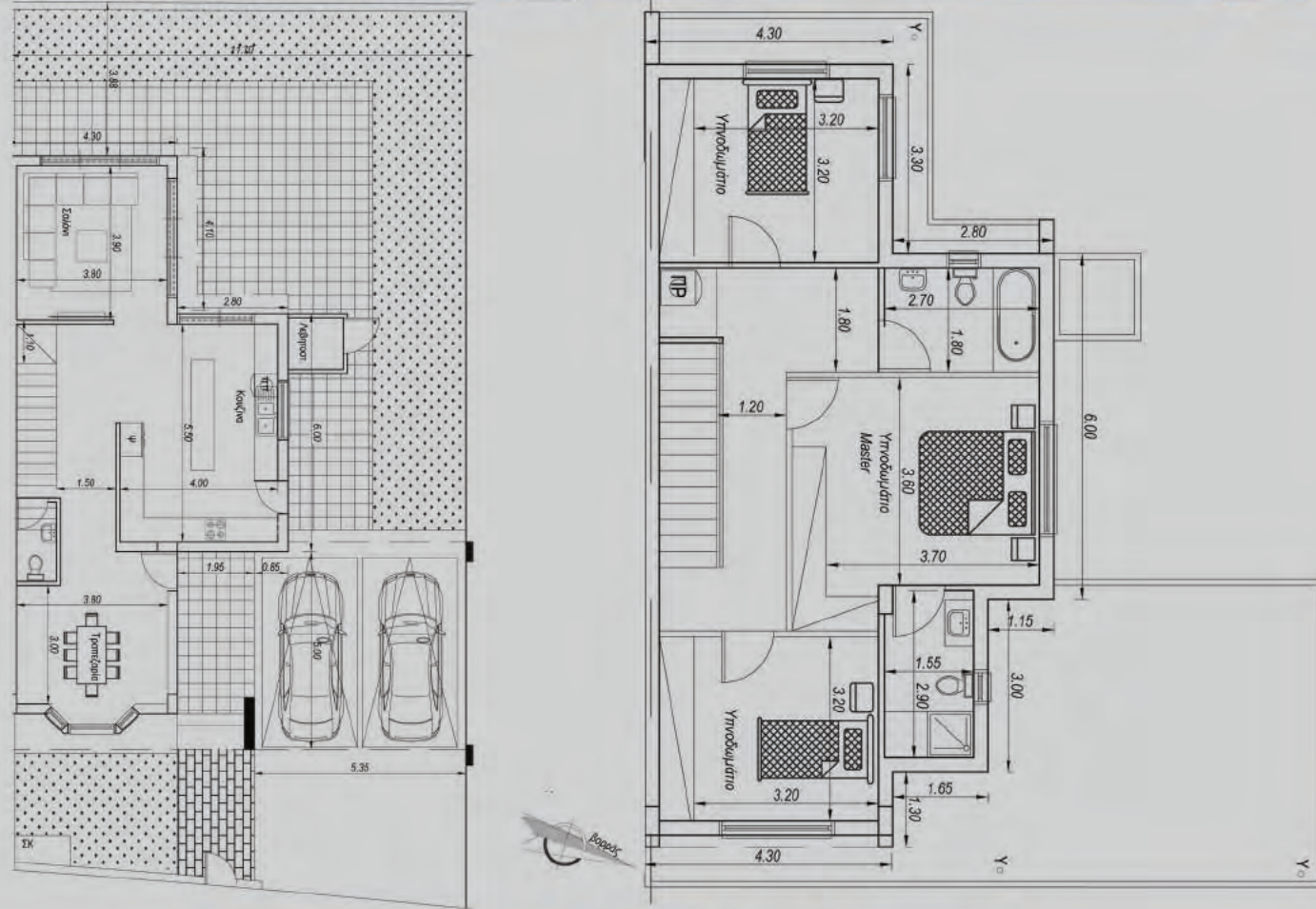

CYVIEW 49



House 49A

House 49B

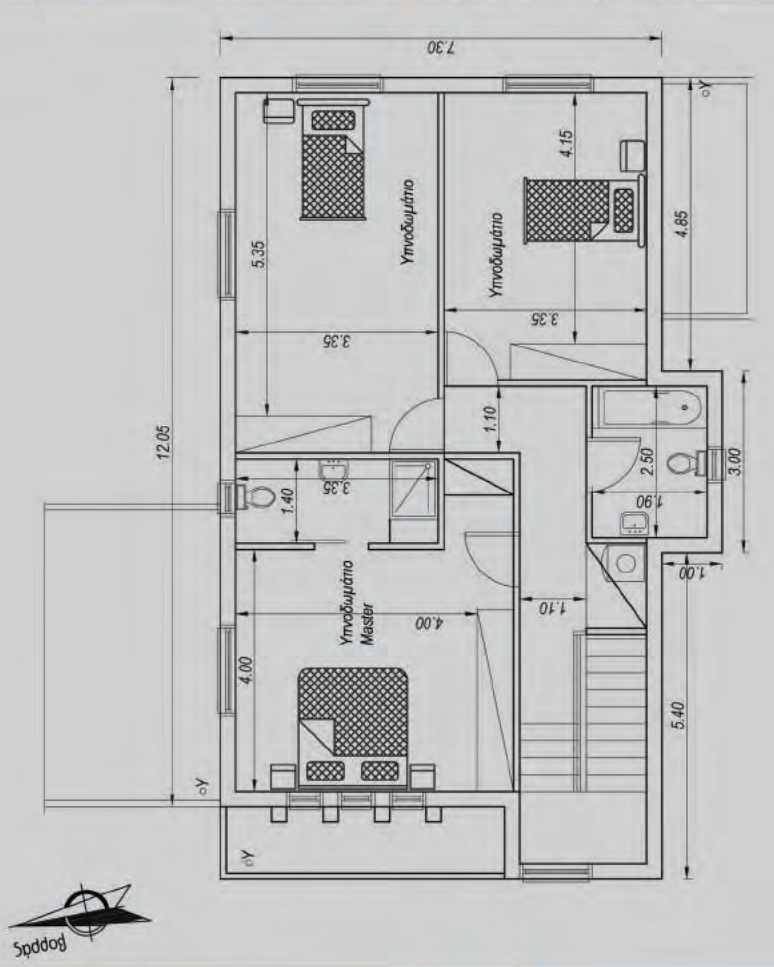
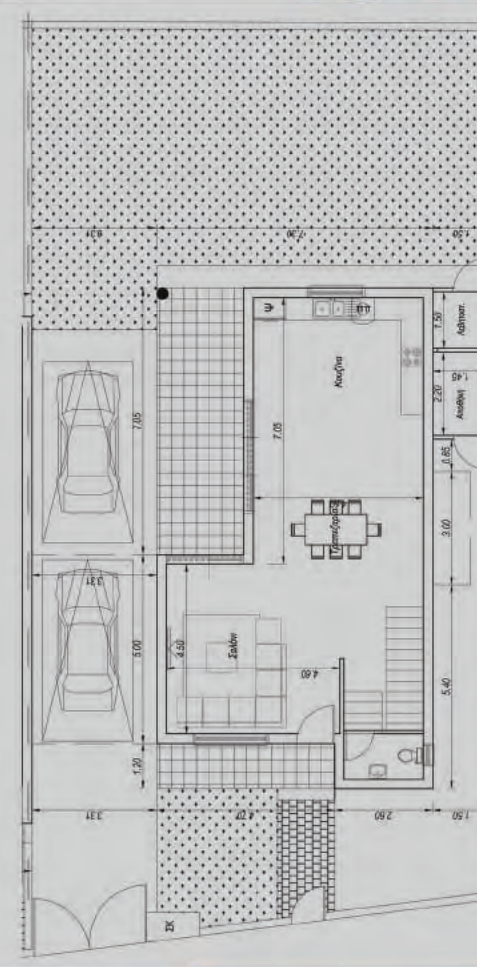
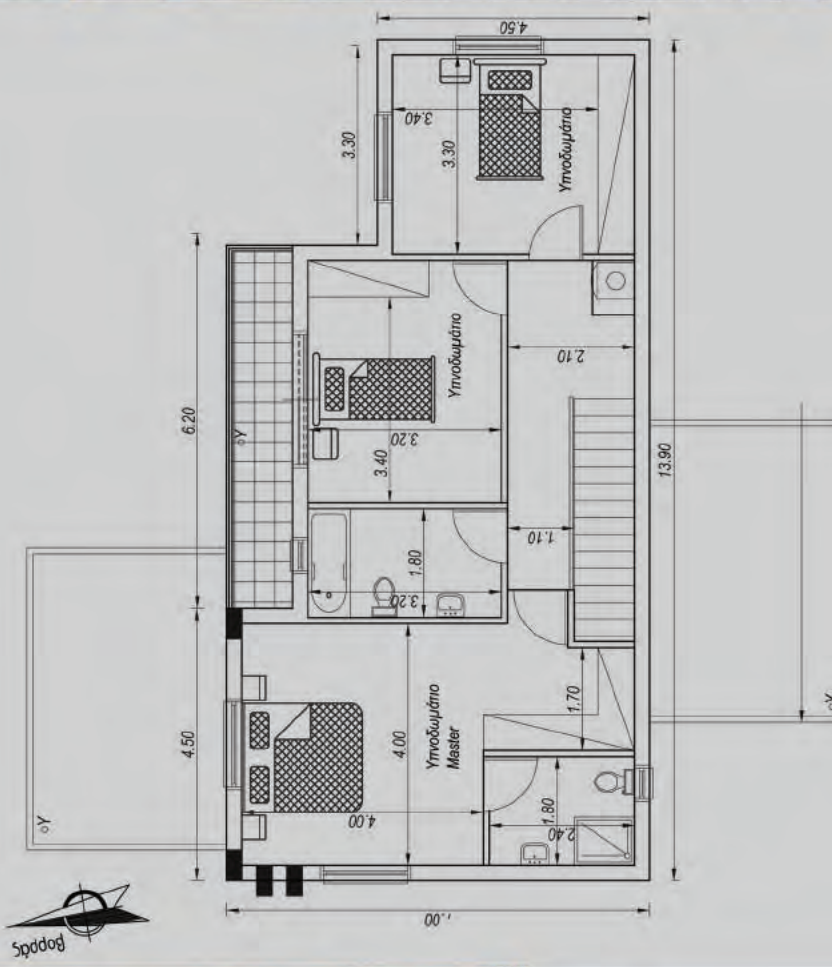
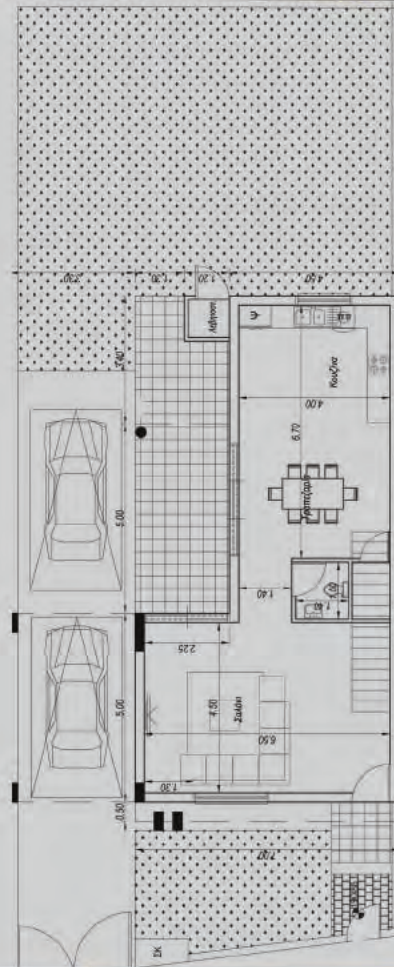

House 49C



47

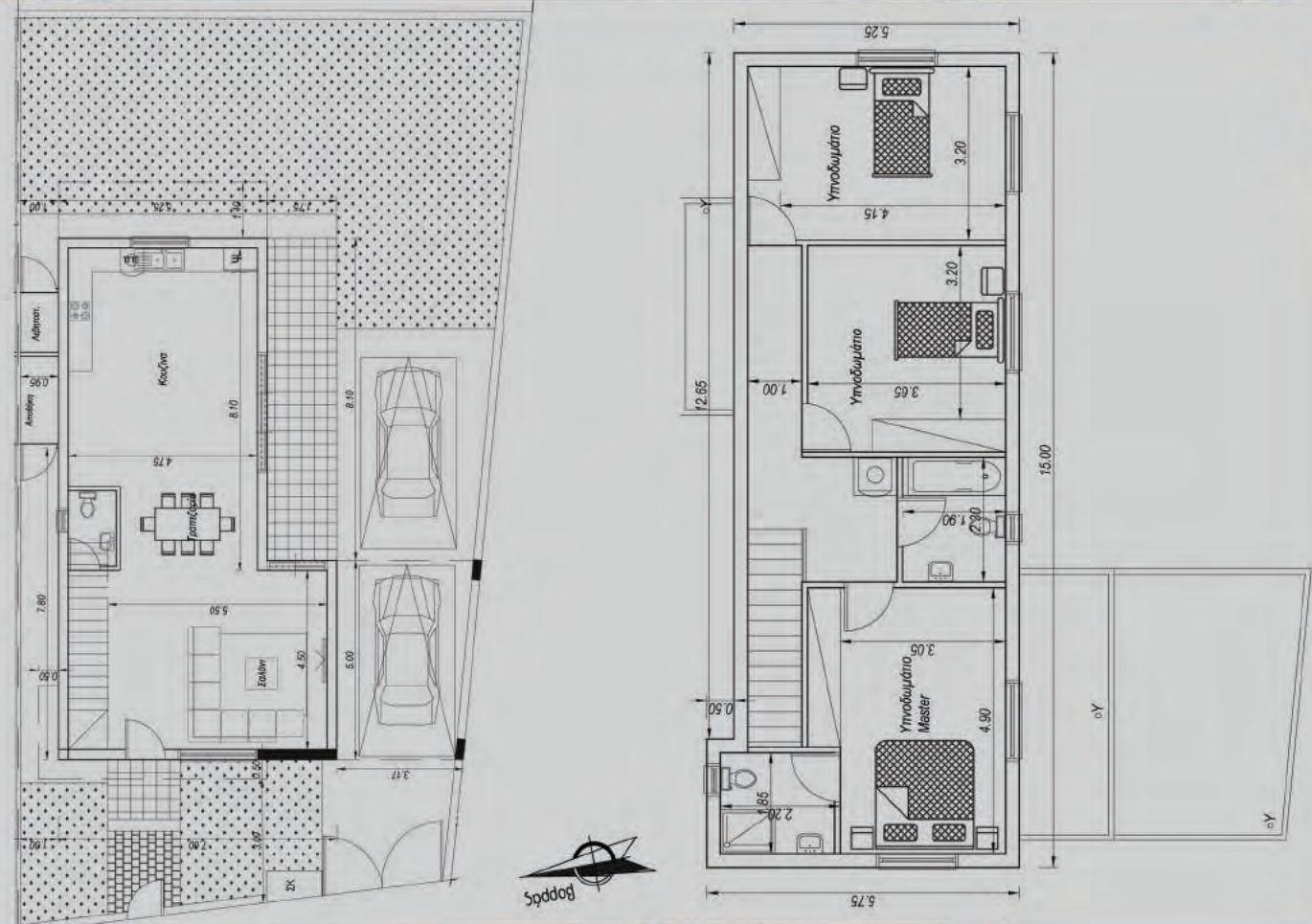

48



49

Interiors 内部装修



Top View 俯视图



Floor Areas 楼层面积

HOUSE 别墅	BEDROOMS 卧室	PLOT SIZE 占地面积 (m ²)	COVERED AREAS 使用面积(m ²)	STORAGE (m ²)	COVERED VERANDAS 阳台面积(m ²)	BOILER ROOM 热水器(m ²)	PARKING SPACE 车位(m ²)	TOTAL COVERED AREAS 总覆盖面积(m ²)
CYVIEW 47								
HOUSE A	3	238	144.33	-	6.10	-	18.05	168.48
HOUSE B	3	260	156.16	-	7.52	-	14.50	178.18
HOUSE C	3	260	155.31	-	11.11	1.56	24.16	192.14
CYVIEW 48								
HOUSE A	3	290	173.31	-	6.70	2.48	30.16	212.65
HOUSE B	3	236	142.42	-	6.30	2.40	15.70	166.82
HOUSE C	3	261	156.71	-	8.00	2.25	28.92	195.88
CYVIEW 49								
HOUSE A	3	261	156.44	-	12.50	1.44	16.50	186.88
HOUSE B	3	290	174.97	3.53	21.86	2.48	21.86	224.70
HOUSE C	3	267	161.46	2.35	-	1.65	17.00	182.46

Location-Map 地理位置



22 Ayiou Georgiou, Office 办公室 202, 2231
 P.O BOX 12657, 2251 Latsia,
 Nicosia 尼科西亚, Cyprus 塞浦路斯
 Tel 联系电话: +357 22486955/ 99304095
 Fax 传真: +357 22488733
 Email 电子邮件: info@cyview-developers.com
 Web 网页: www.cyview-developers.com
 WeChat 微信 ID: Andreascyview

